



888-538-1000
TEL (561) 588-5200
FAX (561) 493-2999
PARTS FAX (561) 493-2990
www.benchmarkgames.com

51 Hypoluxo Rd.
Hypoluxo, FL 33462-4501

SLAM-A-WINNER



**PLEASE READ FIRST BEFORE
PLUGGING IN MACHINE**

ALL RIGHT RESERVED. PAT. PENDING



61-MAN-B

Table of Contents

General Operation.....	3
How Slam-A-Winner plays	
How the Wheel Scores	
How the Ball Lift works	
Programming Options.....	4-6
Troubleshooting Guide.....	7-8
Parts Identification.....	9
Schematics.....	10-13

IMPORTANT: DO NOT USE ABRASIVE CLEANERS ON ANY OF THE GLASS OR ARTWORK.

General Operation

How Slam-A-Winner plays

A player can insert as many tokens as he wishes before he starts dropping balls. Most players prefer this feature.

A player tries to time a ball drop to go thru a desired hole on the rotating wheel (see program options for setup).

Note: A player can play as fast as he wants to. He will never lose any ticket values because of 3 or 4 balls on wheel at one time.

Halogen ball lamp turns on when there is 1 or more credits. 10 seconds after the last credit is used, the ball lamp turns off (in standby the lamp is off).

Note: Replace only with same 20 watt lamp. Do not increase wattage or it may cause damage to the power supply.

How the wheel scores

A pin is located under the wheel at the home position. When this pin passes through the wheel opto sensor the home position is identified. Since we know the position of the wheel at all times, when a ball falls thru a hole that triggers the ball opto sensor, we know the value of that hole and pay tickets accordingly. Wheel opto sensor and wheel home pin can be viewed from front of game without opening front door.

Note: There is an opto sensor for the outside row of holes and a sensor for the inside row.

How ball lift works

7 balls are installed at the factory, more than 7 may jam ball lift.

When a ball is dropped, the ball drop switch closes telling the ball lift motor to run until another ball opens the ball drop switch.

Programming Options

1.) Entering Programming Mode

To enter program mode, press and hold the left button (SW1)① located on the Power Distribution Board②. After 2 seconds, “TOTALS” will appear on the LCD Display③. At this time, release the button. “COINS IN” with the number of coins received will be displayed. The game is now in Program Mode. **PLEASE NOTE** that from this point forward, the left button (SW1)① and the right button (SW3)④ on the Power Distribution Board② are the buttons used. These buttons are referred to on the LCD display as Button 1 and Button 2 respectively. Each programming option is displayed on the LCD Display, with the functions shown for Button 1 and Button 2.

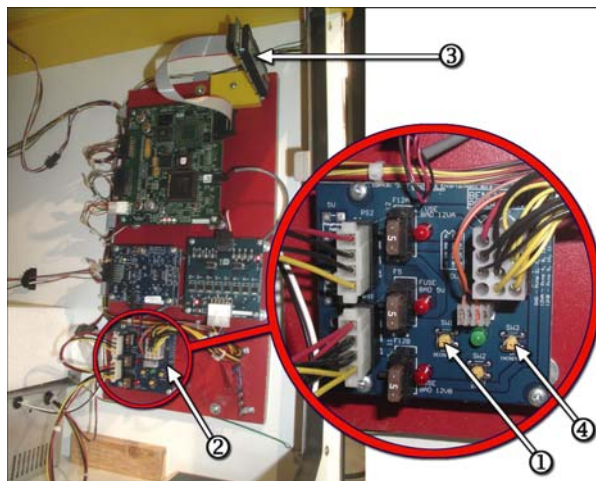

2.) COINS IN

The total coins received through the coin mechanism are displayed. The total will rollover to zero when it reaches 1,000,000. Depressing button 2 will display “TICKETS OUT”.

3.) TICKETS OUT

The total tickets dispensed are displayed. The total will rollover to zero when it reaches 1,000,000. Depressing button 2 will display one of two options:

If there are tickets that have not been dispensed, the Display will show “CLEAR TICKETS OWED?”, otherwise it will display “ENTER PROGRAM MODE?”

4.) “CLEAR TICKETS OWED?”

This option is displayed if there are tickets that are owed that have not been dispensed, and will show the number of tickets. Depressing Button 1 will clear these tickets from the system, and “TICKETS CLEARED” will be displayed. Depressing Button 2 will display “ENTER PROGRAM MODE?”

5.) “ENTER PROGRAM MODE?”

Depressing Button 1 at this time will enter the area of Program Mode where parameters may be changed. Depressing Button 2 will return the game to Run Mode.

6.) “ENTER PASSCODE”

To be able to change programming parameters or reset the counters, a 4-digit passcode must be entered. The default passcode is 0000. To enter the passcode, Depress Button 1 to change the digit from 0 to 9, then press Button 2 to move to the next digit. After all digits have been entered correctly, depressing button 2 will Display the first programming option, “CHANGE PASSCODE?”.

7.) “CHANGE PASSCODE?”

Depressing Button 1 will allow for changing the passcode. Depressing Button 2 will move to “DISPLAY CONTRAST”.

IMPORTANT!!! ONCE THE PASSCODE IS CHANGED, THE DEFAULT OF 0000 WILL NO LONGER WORK! BE SURE TO SAVE THE PASSCODE IN A SAFE PLACE!

Entering the new passcode is accomplished in the same way that entering the passcode is done, as explained in 6.) .

8.) DISPLAY CONTRAST

This option sets the contrast for the LCD Display. Depress and hold Button 1 until the desired contrast is reached, then release Button 1. Depressing Button 2 will move to the next option, “PLAY MODE VOLUME”.

9.) PLAY MODE VOLUME

This option sets the speaker volume during game play. When this option is entered, the game’s background music will play continuously. Depressing Button 1 will increase/decrease the volume. As long as Button 1 is depressed, the volume will increase until the maximum is reached, then decrease until the volume is off. Depress and hold Button 1 until the desired volume is reached. Depressing Button 2 will display the next option, “ATTRACTION MODE VOLUME”.

10.) ATTRACTION MODE VOLUME

This option sets the speaker volume during Attraction Mode. When this option is entered, the game’s background music will play continuously. Depressing Button 1 will increase/decrease the volume. As long as Button 1 is depressed, the volume will increase until the maximum is reached, then decrease until the volume is off. Depress and hold Button 1 until the desired volume is reached. Depressing Button 2 will display the next option, “ATTRACTION FREQUENCY”.

11.) ATTRACTION FREQUENCY

This option sets the frequency at which the attraction mode occurs. The settings are from OFF to every 30 minutes. Depressing Button 1 will change the settings in 1-minute increments from OFF to 30 minutes, then back to OFF. Depressing Button 2 displays the next option, “COINS PER CREDIT”.

12.) COINS PER CREDIT

This option sets the number of coins required for a credit. The settings are from 1 to 4 coins per credit. Depressing Button 1 will change the setting from 1 to 4, then back to 1. Depressing Button 2 displays the next option, “BALLS PER CREDIT”

13.) BALLS PER CREDIT

This option sets the number of balls per credit. The settings are from 1 to 3 balls per credit. Depressing Button 1 will change the setting from 1 to 3, then back to 1. Depressing Button 2 displays the next option, “JACKPOT INCREMENT”.

14.) JACKPOT INCREMENT

Every time a coin is inserted into the game, the jackpot value is incremented by this amount. The setting is from an increment of 1 to 10. Depressing Button 1 will change this setting from 1 to 10, and then revert back to 1. Depressing Button 2 will display the next option, “SET WHEEL TYPE”.

15.) SET WHEEL TYPE

This option sets the type of wheel being used. Depressing button 1 will select the type of wheel being used. Depressing Button 2 displays the next option, “SET WHEEL SPEED”.

16.) SET WHEEL SPEED

This option sets the speed of the wheel rotation. Depressing button 1 will increase the wheel speed from 0 to 5 units over the base speed. Depressing Button 2 displays the next option, setting the “JACKPOT START VALUE”.

17.) JACKPOT START VALUE

This option sets the starting value for the jackpot. This option only appears if the STANDARD wheel type is selected. Depressing button 1 will increase the start value from 100 to 150 in increments of 5, then back to 100. Depressing Button 2 displays the next option, resetting the total for COINS IN

18.) RESETTING TOTALS

The totals displayed at the beginning of Program Mode (COINS IN, TICKETS OUT) may be reset to zero here. The total number for each will be displayed. Depressing Button 1 will clear the total, and zero will be displayed, confirming that the count has been cleared. Depressing Button 2 will display the next total. Depressing Button 2 after all of the totals have been displayed will display the next option, “ENTER FREE PLAY MODE?”

19.) “ENTER FREE PLAY MODE?”

If Button 1 is depressed, the game will enter free play mode. This mode is for diagnostic purposes. In this mode, there is always a credit present on the game, without coins being inserted.

NOTE: The only way to exit this mode is to turn the power off to the game, or to re-enter Program Mode and select “NO” for this option. In addition, music plays continuously in this mode.

When this option is displayed, depressing Button 2 will display the next option, “ENTER PROGRAM MODE?”

20.) “ENTER PROGRAM MODE?”



This option gives the opportunity to re-enter program mode if it is necessary to change any options again. Depressing Button 2 leaves Program Mode and the game returns to normal, Run Mode.

DEFAULT SETTINGS

PASSCODE	0000
PLAY MODE VOLUME	42
ATTRACTION MODE VOLUME	42
ATTRACTION FREQUENCY	5 Minutes
COINS PER CREDIT	1 Coin
BALLS PER CREDIT	1 Ball
JACKPOT INCREMENT	1 point
WHEEL TYPE	STANDARD
WHEEL SPEED	+0
JACKPOT START VALUE	125 ⁽¹⁾

- (1) The Jackpot Start Value programming option is enabled for the STANDARD wheel only.

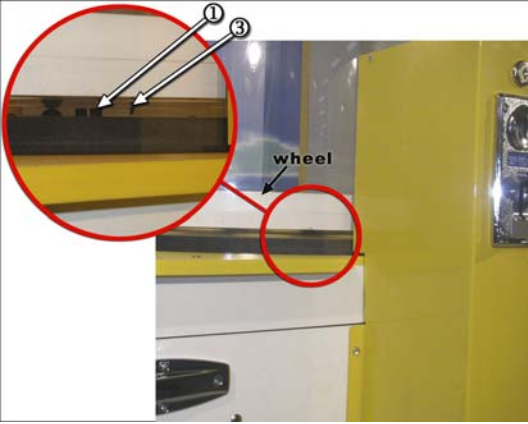
Troubleshooting Guide

Problem	What to Check
<p>Wheel runs briefly, stops, and restarts over and over again</p> 	<ol style="list-style-type: none"> 1. Check <u>wheel opto</u>① operation; <u>wheel opto light</u>② should flash once per wheel revolution when <u>wheel pin</u>③ (pressed into the bottom of the wheel) passes through opto. If light does not flash: <ul style="list-style-type: none"> • <u>Wheel pin</u>③ may not be low enough to break opto beam • Power may not be connected to wheel opto pcb 2. Check opto output; opto should transition from +5V to 0V when opto beam is broken. If opto pcb has power but there is not transition on the output, the opto pcb is bad. If signal transitions all the way back to the Controller board, controller board may be bad. 3. Check motor adjustment.
<p>Ball does not drop when ball drop button is pressed <i>and</i> ball drop button does not illuminate when credits are available</p>	<ol style="list-style-type: none"> 1. Check <u>ball ramp switch</u>④ adjustment 2. Make sure the output wire is connected to the NC (normally closed) side of the ball ramp switch.
<p>Ball does not drop when ball drop ball button is pressed <i>and</i> ball drop button does illuminate when credits are available</p> 	<ol style="list-style-type: none"> 1. Check for out of round or oversized balls. Check ball size by inserting them into the Jackpot hole in the wheel. They should pass through the holes without interference. 2. Check <u>ball drop solenoid</u>⑤ (if solenoid does not move at all, it is most likely the ball ramp switch) 3. Check wire connection to <u>ball ramp switch</u>④, <u>ball drop solenoid</u>⑤, and <u>ball release button</u>⑥
<p>Ball Lift Jams</p>	<p>Too many balls in machine. There should be 7 balls loaded in the machine.</p>
<p>Ball lift runs forward, then backward, then forward again over and over and/or Balls build up on ball ramp</p>	<p><u>Ball ramp switch</u>④ is out of adjustment or not working. Switch output should be connected to NC terminal.</p>

Balls do not score

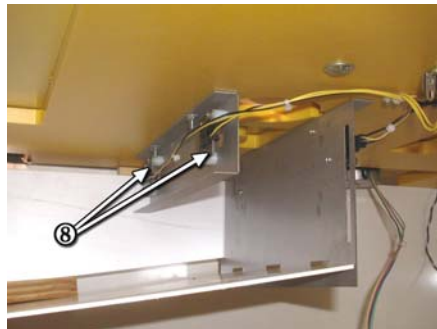

1. Check ball sensing opto sensors to see if ball opto light⑦ goes on when opto beam is blocked. If light does not go on:
 - Check power to opto receiver⑨ sensor pcb's
 - Check output signal from the opto receiver⑨ pcb. Output from opto receiver should transition from +5V to 0V when opto beam is blocked. If not, the opto receiver should be replaced.
2. If ball opto light⑦ is always on:
 - Check power to opto transmitters⑧
 - Check to be sure that the opto transmitters⑧ and receivers are in alignment.
3. If ball opto light⑦ does go on and the output transition from the opto receiver pcb is detected all the way to the controller board, then the controller board is bad.

Note: You will need to remove the ball cover⑩ by removing the cotter pin⑪ to access transmitter side of opto sensors and to block opto path for testing.

Game does not power on

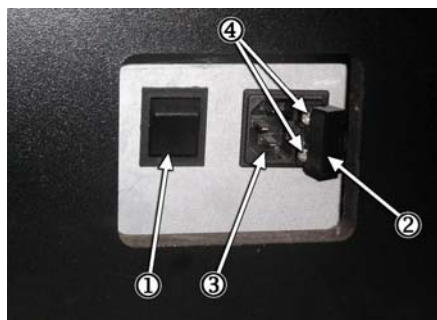

1. Check that power switch① is in the "ON" position
2. Check that power cord is good
3. Check power input fuses:
 - a. With a small flat head screwdriver, pull the fuse holder② out. Fuse holder is located next to the power input plug③.
 - b. Tilt the fuse holder cover to the side to access fuses④
 - c. Replace fuses (5 Amp) if necessary and push fuse holder back into place.

Parts Identification

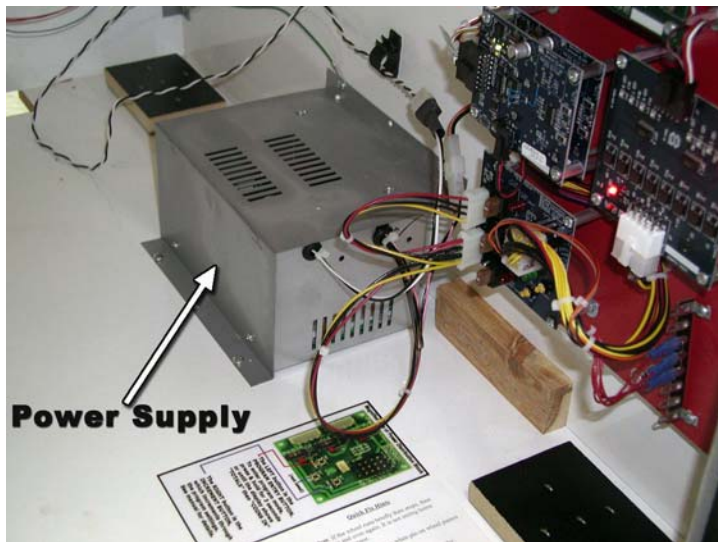
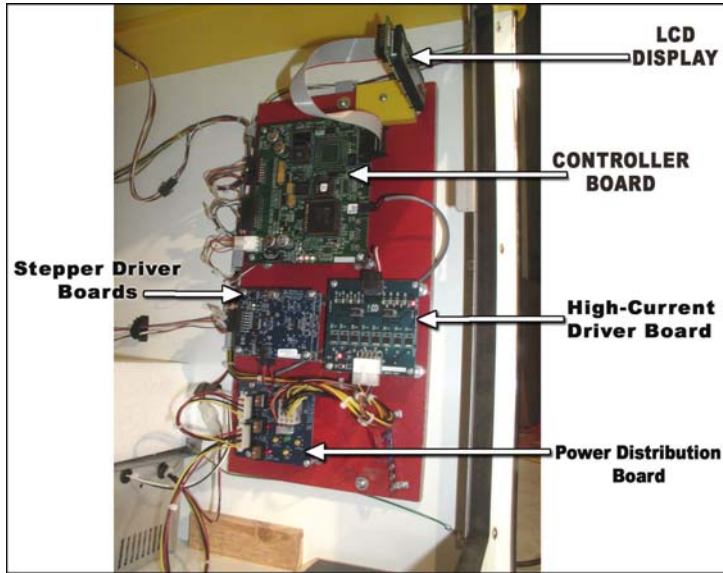

slam-a-winner
 ac power schematic 90 volts to 240 volts
 standby amp. 1.5
 max. amp. 2

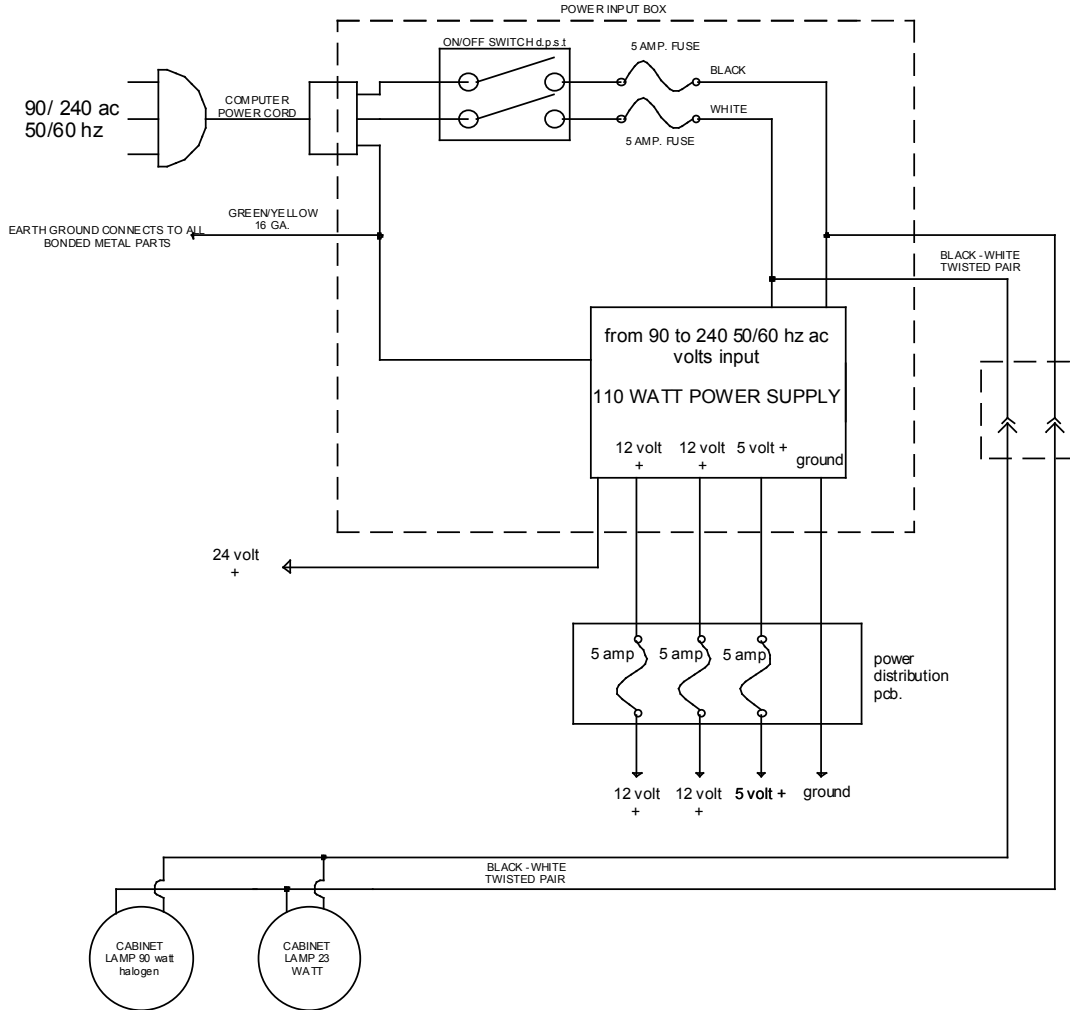

slam-a-winner connector location

C- is symbol for connector

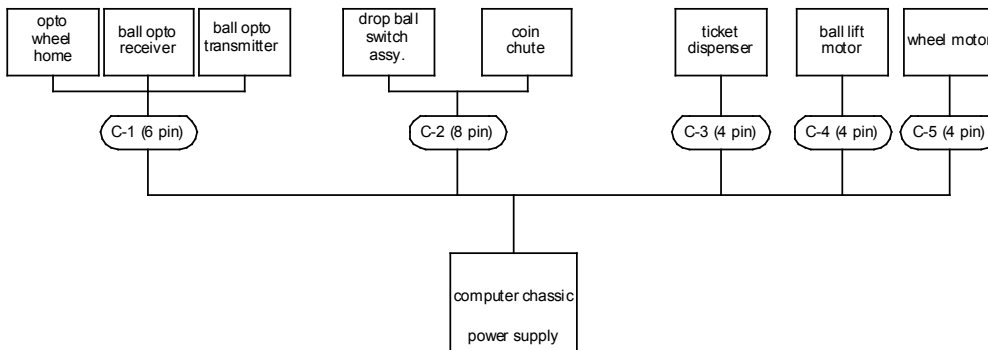

slam-a-winner front door

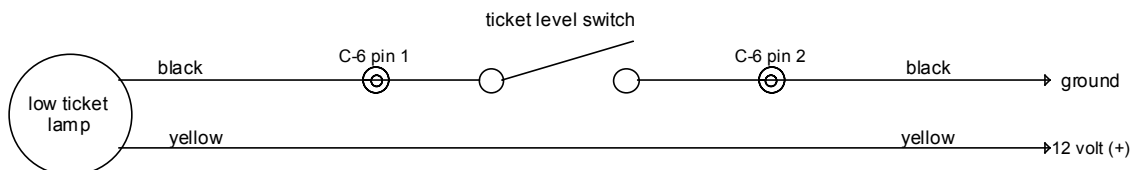
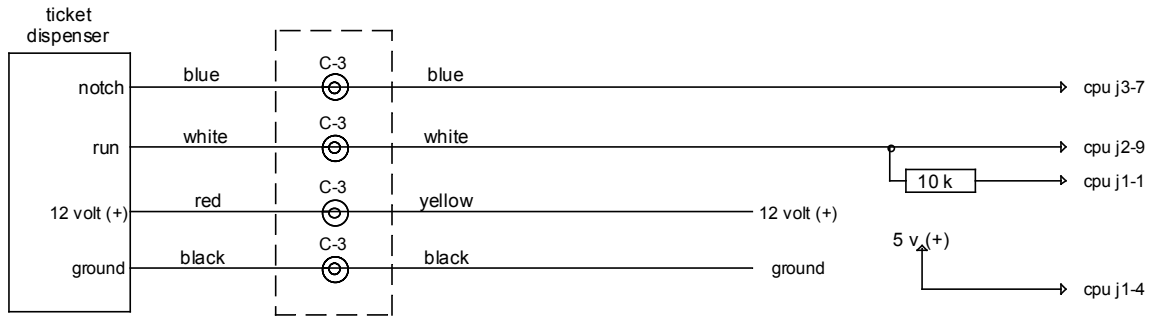
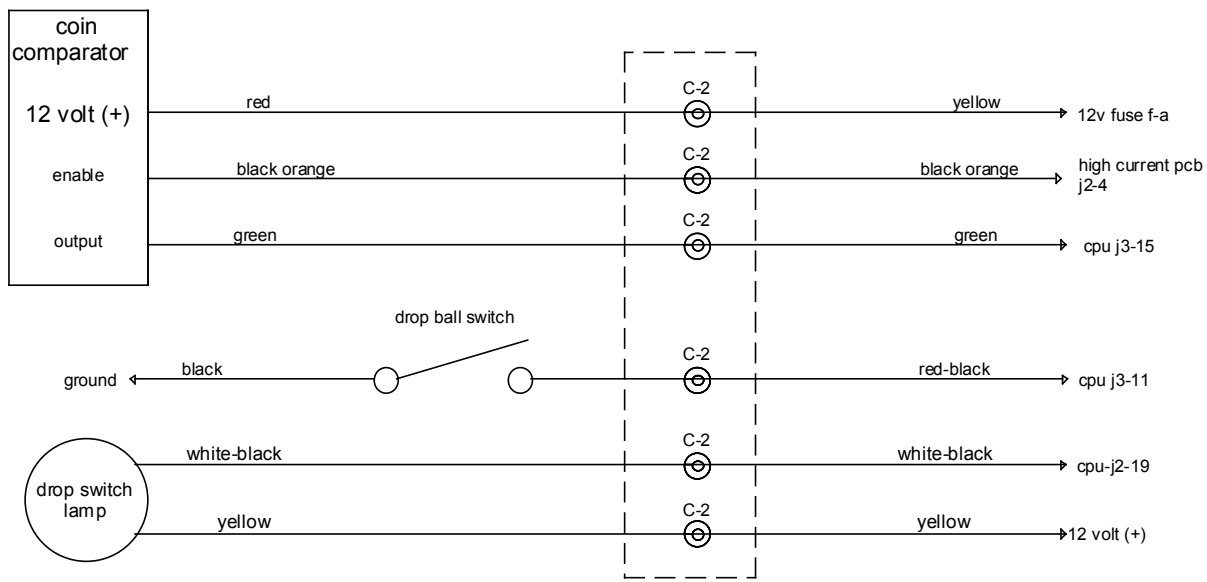
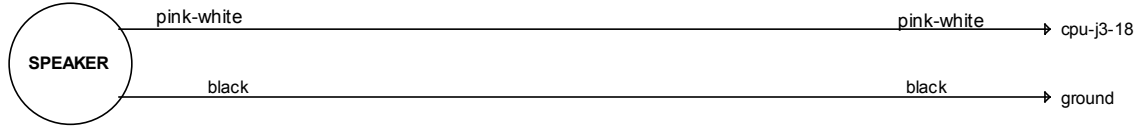

slam-a-winner

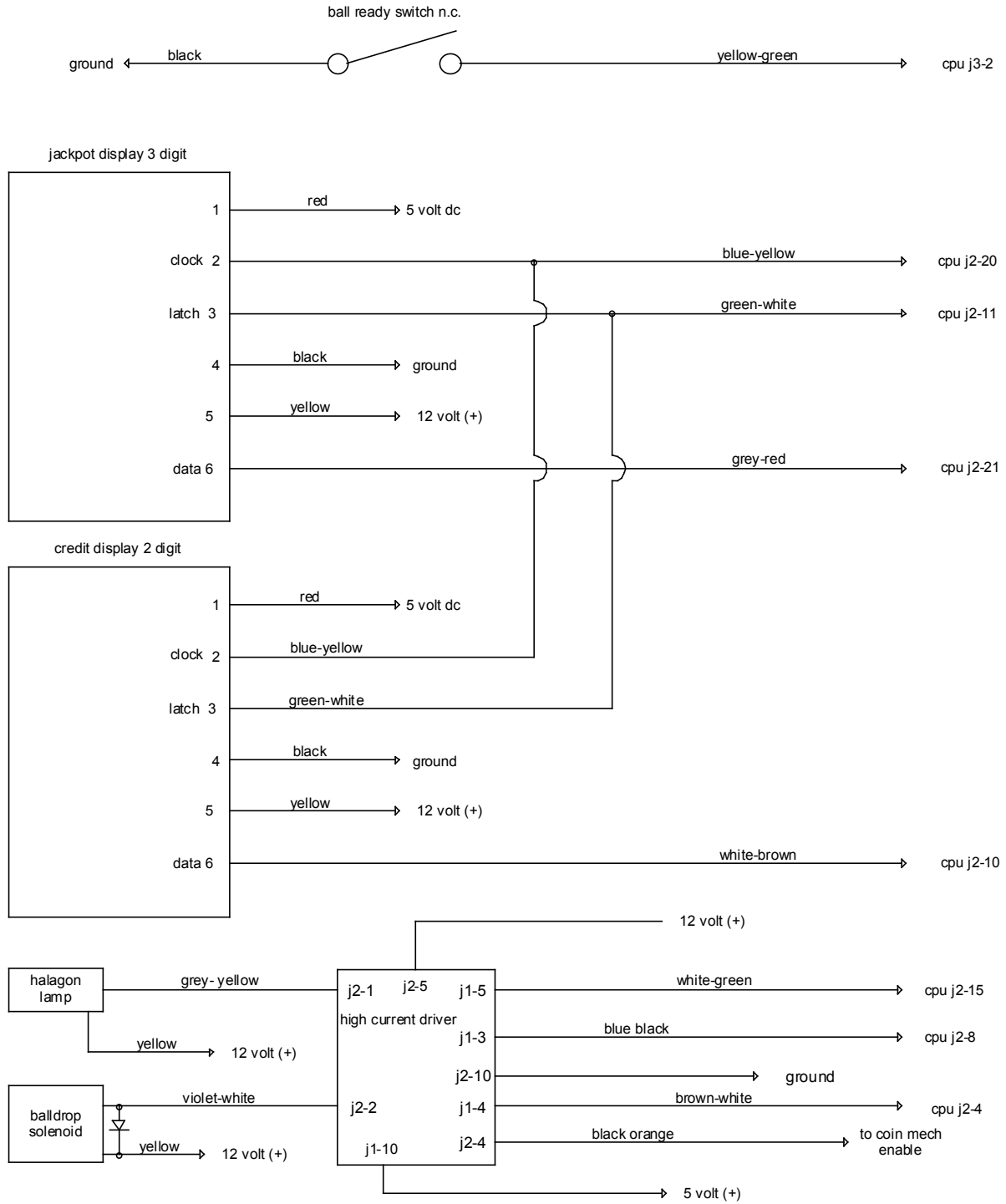

slam-a-winner

ball lift motor 30 ohm

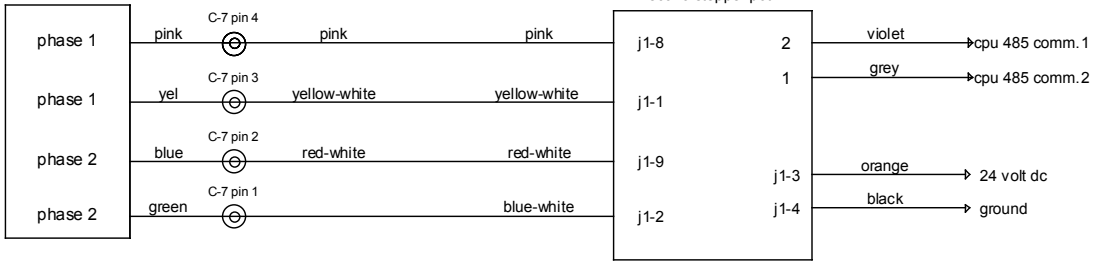

wheel motor 30 ohm

